

Inlet filter, front side mounting, fuseholder 5x20 mm

Plug removal necessary for fuse replacement

Snap-In Version or Screw-On Version
Typ 5220, Fuseholder 2-poleSnap-In Version or Screw-On Version
Typ 5220, Fuseholder 2-pole

C14



70° C

**Description**

- Panel Mount:
Snap-in or screw-on mounting from front side
- 3 Functions:
Inlet Protection class I, Fuseholder for fuse-links 5 x 20 mm 2-pole, Line filter in standard and medical version
- Quick connect terminals 6.3 x 0.8 mm
- Alternative: version without line filter [6220](#)

Approvals

- VDE License Number: 101307
- UL License Number: E72928
- CSA License Number: 97784

Characteristics

- All single elements are already wired
- Plug removal necessary for fuse-link replacement
Fuse drawer meets requirements of medical standard IEC/EN 60601-1
The fuseholder is accessible from the equipment front
- Qualified for use in equipment according IEC/EN 60950

References[General Product Information](#)**Weblinks**[Approvals](#), [RoHS](#), [CHINA-RoHS](#), [e-Store](#), [SCHURTER-Stock-Check](#), [Distributor-Stock-Check](#)**Technical Data**

Ratings IEC	1 - 10A @ Ta 40 °C / 250VAC; 50Hz	Appliance-Inlet /-Outlet	C14 acc. to IEC/EN 60320-1, UL 498, CSA C22.2 no. 42 (for cold condition) pin-temperature 70 °C, 10A, Protection class I
Ratings UL/CSA	1 - 10A @ Ta 40 °C / 125VAC; 60Hz	Fuseholder	2-pole, Shocksafe category PC2 acc. to IEC 60127-6, for fuse-links 5 x 20mm
Leakage Current	standard < 0.5mA (250V / 60Hz) medical < 5 µA (250 V / 60 Hz)	Rated Power Acceptance @ Ta 23 °C	5 x 20: 1.6W (2-pole)
Dielectric Strength	> 1.7kVDC between L-N > 2.7kVDC between L/N-PE Test voltage (2 sec)	Power Acceptance @ Ta > 23°C	Admissible power acceptance at higher ambient temperature see derating curves
Allowable Operation Temp.	-25°C to 85°C	Line Filter	Standard and Medical Version, IEC 60939, IEC 60601-1, UL 1283, UL 544, EN 133 200, CSA C22.2 no. 8 Technical details
Climatic Category	25/085/21 acc. to IEC 60068-1	MTBF	> 2'300'000h acc. to MIL-HB-217 F
Degree of Protection	from front side IP 40 acc. to IEC 60529		
Protection Class	Suitable for appliances with protection class I acc. to IEC 61140		
Terminal	Quick connect terminals 6.3 x 0.8 mm		
Panel Thickness s	Screw-on: max 8mm Mounting screw torque max 0.5Nm Snap-in: 0.8mm to 3mm		
Material: Housing	Thermoplastic, black, UL 94V-0		

Dimensions

Screw-on mounting type 5220

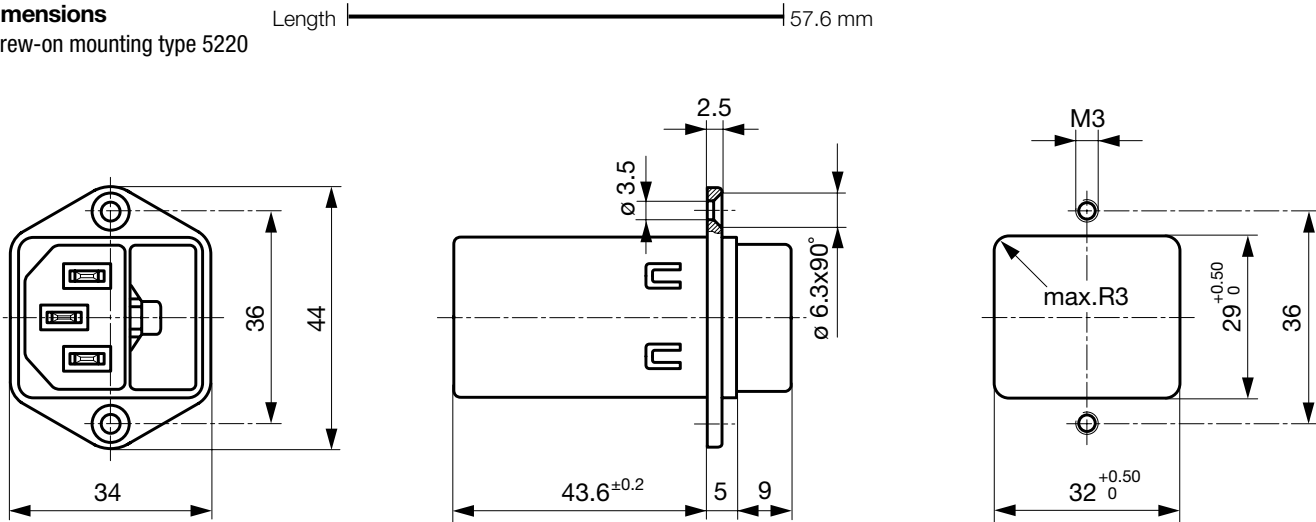

Snap-in mounting type 5220

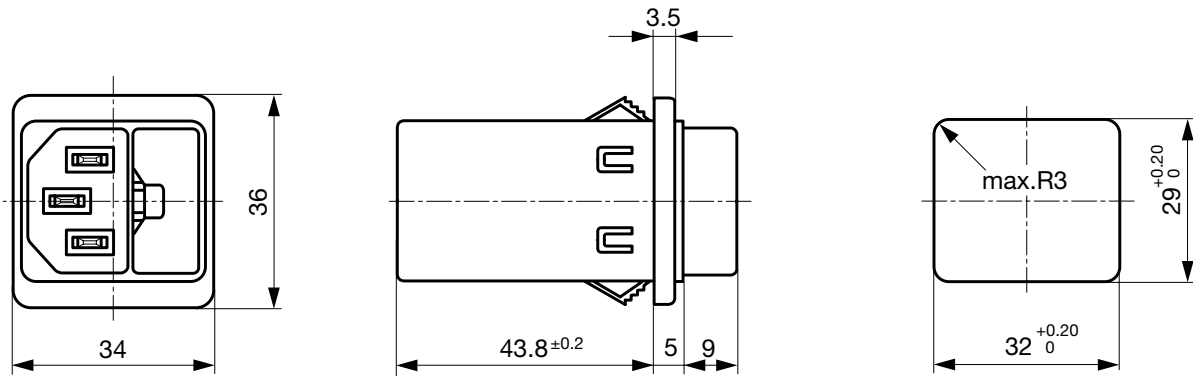

Technical Data of Filter-Components

Rated Current [A]	Filter-Type	Inductances L [mH]	Capacitance CX [nF]	Capacitance CY [nF]	R [MΩ]
1	Standard Version	2 x 11	47	2.2	-
2	Standard Version	2 x 4	47	2.2	-
4	Standard Version	2 x 1.6	47	2.2	-
6	Standard Version	2 x 0.7	47	2.2	-
8	Standard Version	2 x 0.6	47	2.2	-
10	Standard Version	2 x 0.4	47	2.2	-
1	Medical Version (M5)	2 x 11	47	-	1
2	Medical Version (M5)	2 x 4	47	-	1
4	Medical Version (M5)	2 x 1.6	47	-	1
6	Medical Version (M5)	2 x 0.7	47	-	1
8	Medical Version (M5)	2 x 0.6	47	-	1
10	Medical Version (M5)	2 x 0.4	47	-	1

Diagrams

5220 Standard version

5220 Medical version

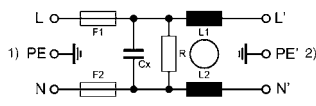
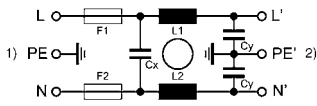

1) Line
2) Load

Derating Curves

2-pole (per pole)

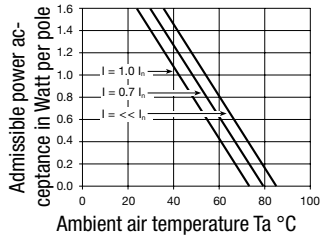

Attenuation Loss

--- differential mode ____ common mode

Standard version

1 A

2 A

4 A

6 A

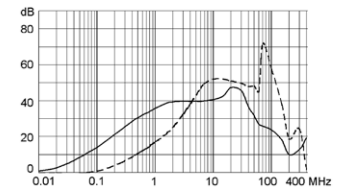
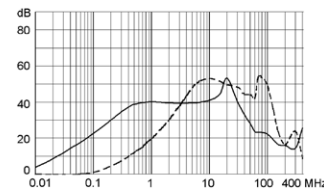
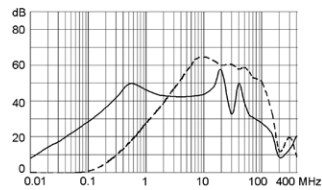
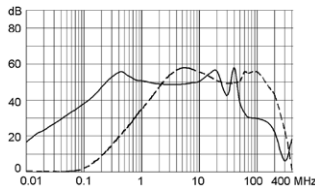

8 A

10 A

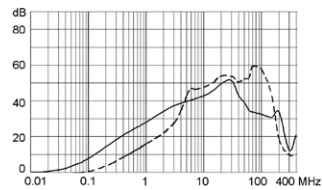
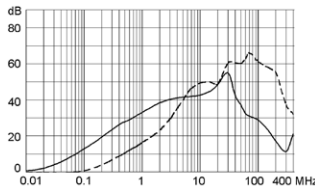

Medical version (M5)

1 A

2 A

4 A

6 A

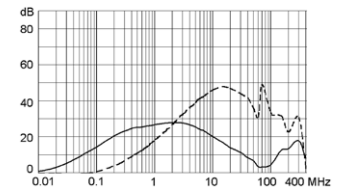
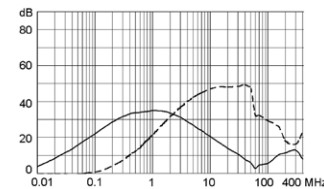
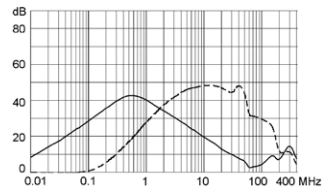
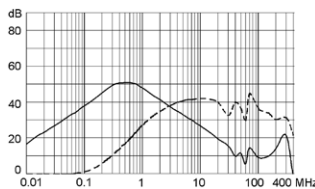

8 A

10 A

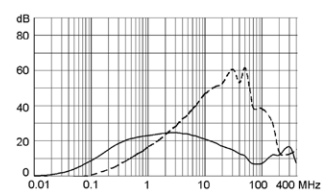
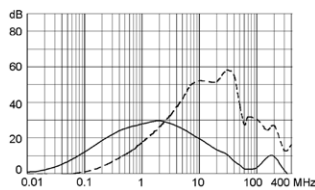

Variants

Socket and fuse-carrier included

Rated Current [A]	Filter-Type	Panel mounting	Fuseholder	Order Number
1	Standard Version	Snap-in	2-pole	5220.0143.1
2	Standard Version	Snap-in	2-pole	5220.0243.1
4	Standard Version	Snap-in	2-pole	5220.0443.1
6	Standard Version	Snap-in	2-pole	5220.0643.1
8	Standard Version	Snap-in	2-pole	5220.0843.1
10	Standard Version	Snap-in	2-pole	5220.1043.1
1	Standard Version	Screw-on	2-pole	5220.0123.1
2	Standard Version	Screw-on	2-pole	5220.0223.1
4	Standard Version	Screw-on	2-pole	5220.0423.1
6	Standard Version	Screw-on	2-pole	5220.0623.1
8	Standard Version	Screw-on	2-pole	5220.0823.1
10	Standard Version	Screw-on	2-pole	5220.1023.1
1	Medical Version (M5)	Snap-in	2-pole	5220.0143.3
2	Medical Version (M5)	Snap-in	2-pole	5220.0243.3
4	Medical Version (M5)	Snap-in	2-pole	5220.0443.3
6	Medical Version (M5)	Snap-in	2-pole	5220.0643.3
8	Medical Version (M5)	Snap-in	2-pole	5220.0843.3
10	Medical Version (M5)	Snap-in	2-pole	5220.1043.3
1	Medical Version (M5)	Screw-on	2-pole	5220.0123.3
2	Medical Version (M5)	Screw-on	2-pole	5220.0223.3
4	Medical Version (M5)	Screw-on	2-pole	5220.0423.3
6	Medical Version (M5)	Screw-on	2-pole	5220.0623.3
8	Medical Version (M5)	Screw-on	2-pole	5220.0823.3
10	Medical Version (M5)	Screw-on	2-pole	5220.1023.3

Packaging unit 10 Pcs**Accessory****Description**

Assorted Covers
Rear Cover

0859.0075



Cord retaining kits
Cord retaining strain relieve

Countersunk, B

4700.0002